

CÓMODO
MUEBLES

MESA CENTRO JOSEFINA

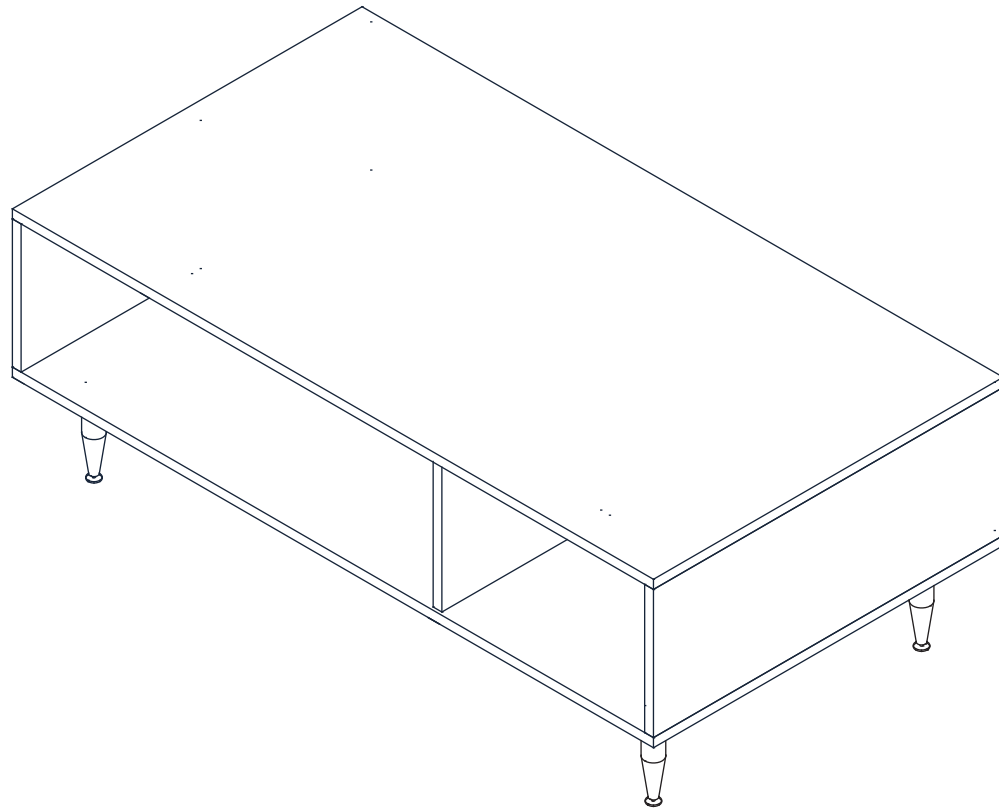

INSTRUCTIVO DE ARMADO

MESA CENTRO JOSEFINA
Diseño: Valentina Barahona E.

Cada pieza está enumerada y la quincallería está identificada con letras. Para armar el mueble, siga el orden en que se presentan los esquemas y arme de forma consecutiva los números.





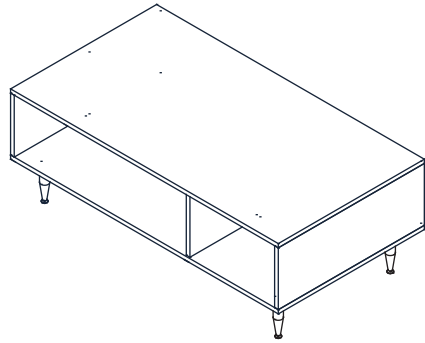

DISEÑO
FABRICACIÓN
CHILENA

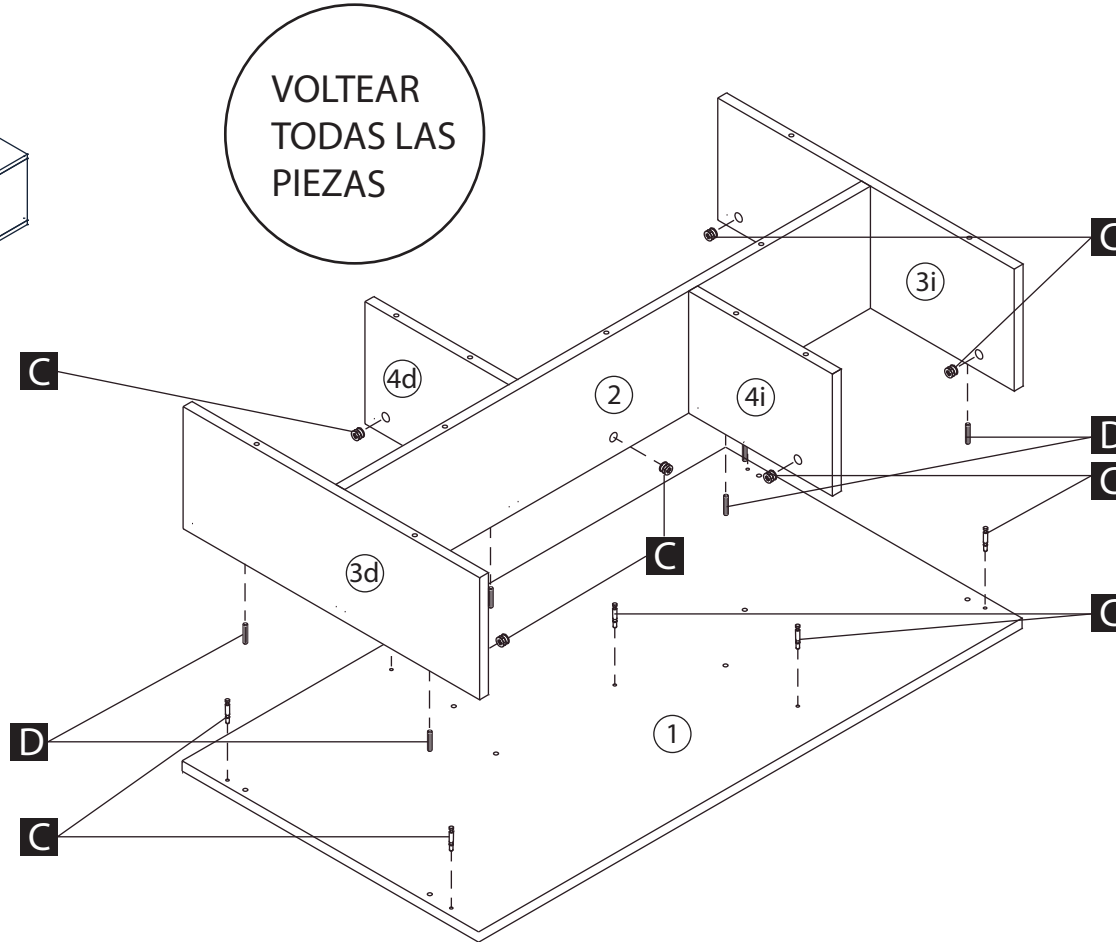
HOJA
01



VOLTEAR
TODAS LAS
PIEZAS

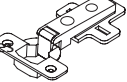
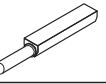

- A** TORNILLOS SPACK 5
07 unidades 
- B** TORNILLOS SPACK 3
16 unidades 
- C** MINI FIX
07 unidades 
- D** TARUGOS
07 unidades 
- E** BISAGRAS
00 unidades 
- F** SISTEMA TIP
00 unidades 
- G** SOPORTES REPISA
00 unidades 
- H** TOPES INFERIORES
00 unidades 

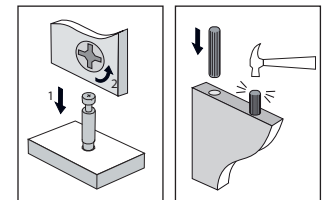

INSTRUCTIVO DE ARMADO

MESA CENTRO JOSEFINA
Diseño: Valentina Barahona E.

Cada pieza está enumerada y la quincallería está identificada con letras. Para armar el mueble, siga el orden en que se presentan los esquemas y arme de forma consecutiva los números.

DISEÑO
FABRICACIÓN
CHILENA

HOJA
02

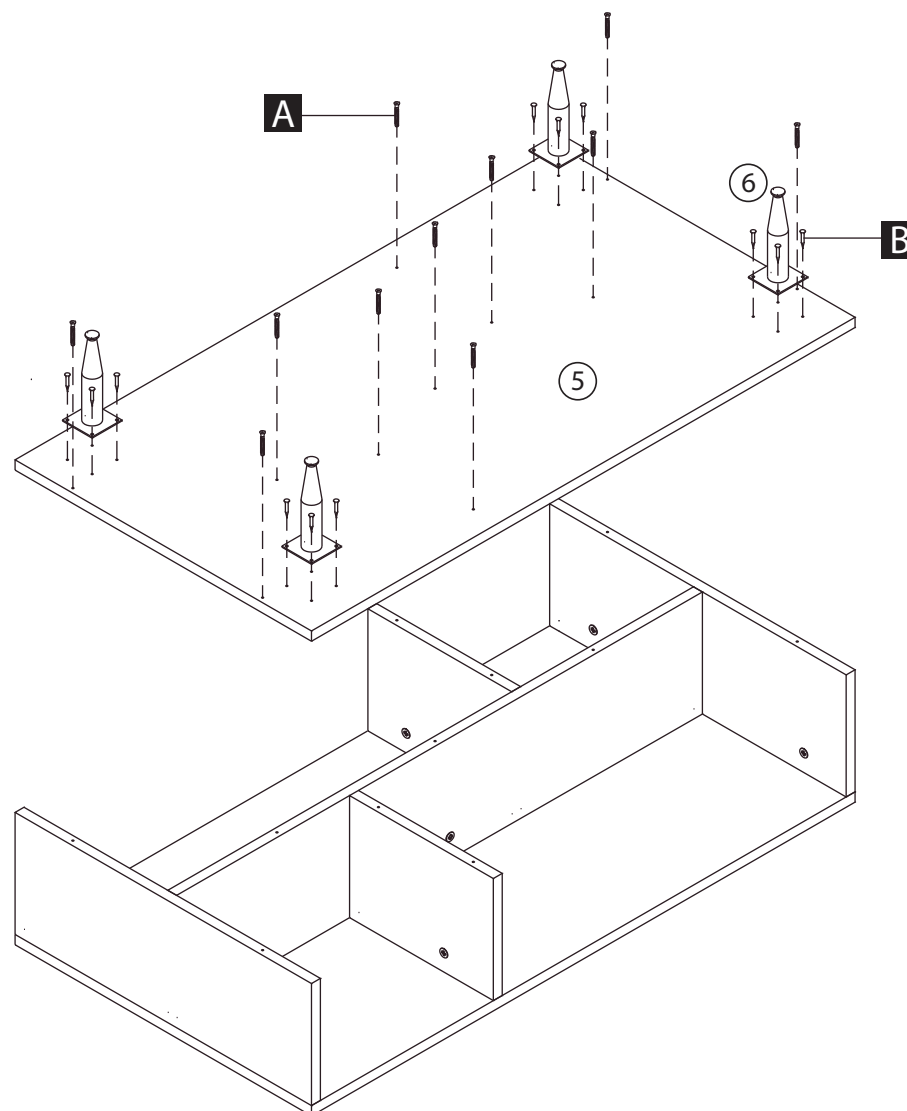

A TORNILLOS SPACK 5
07 unidades



B TORNILLOS SPACK 3
16 unidades



C MINI FIX
07 unidades

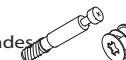

D TARUGOS
07 unidades



E BISAGRAS
00 unidades

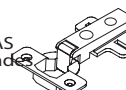

F SISTEMA TIP
00 unidades

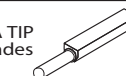

G SOPORTES REPISA
00 unidades



H TOPES INFERIORES
00 unidades

